

Contents | 02 08 2024

- Contents
- Omnitub 1400 x 1400 x 625 Specification Sheet
- Omnitub Feet (Non Seated Tubs)
- Installed Omnitub Height
- Cutting The Sides Of An Omnitub (Non Seated Tubs)
- Drilling Overflows
- Drilling Tap Holes
- Door Ways
- Omnitub Panels
- Cleaning Guide
- Manufacturers Guarantee
- Warranty

TECHNICAL DATASHEET

Omnitub Duo Extreme 1400 x 1400 mm

KEY INFORMATION

External Length	1400 mm
External Width	1400 mm
Dry Weight	50.80 kg
Number Of Feet	8
Water Capacity	740 litres
Warranty	30 years
Minimum Door Width	630 mm
Internal Finish	Resin GRP Polished
External Finish	Fibreglass

Dimensions are shown in millimetres.

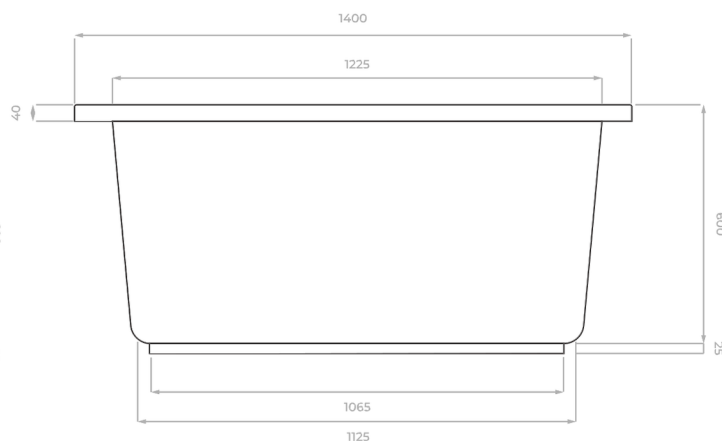
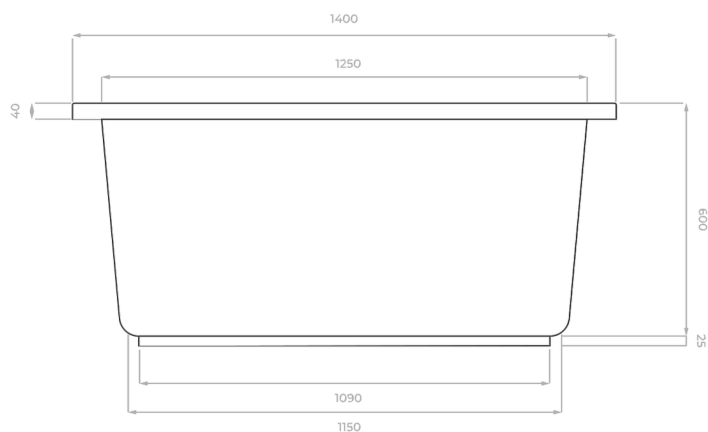
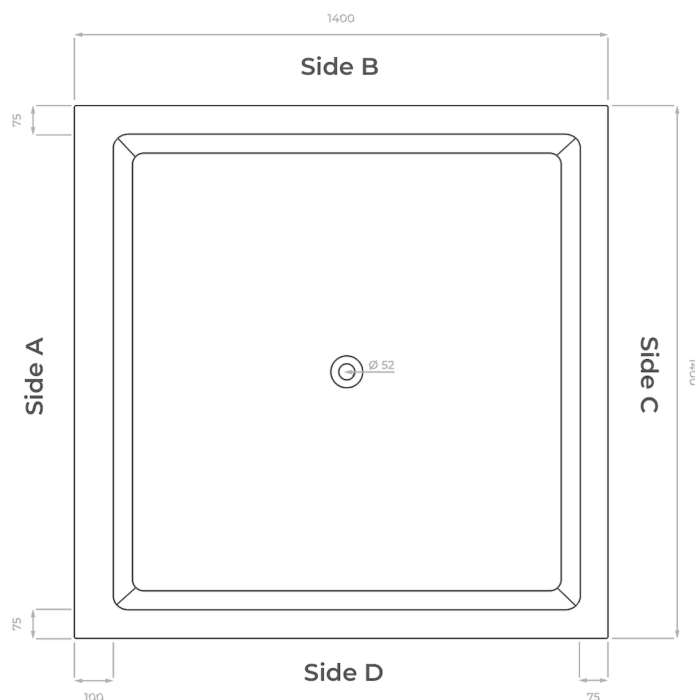

Notes

Our guarantee is subject to the product having been installed, used and maintained in accordance with our instructions. The guarantee applies to the original purchaser and is nontransferable. We recommend that this product is installed by a professional bathroom installer or fitter.

Included Omnitub® Feet Kit (Non Seated Tubs)

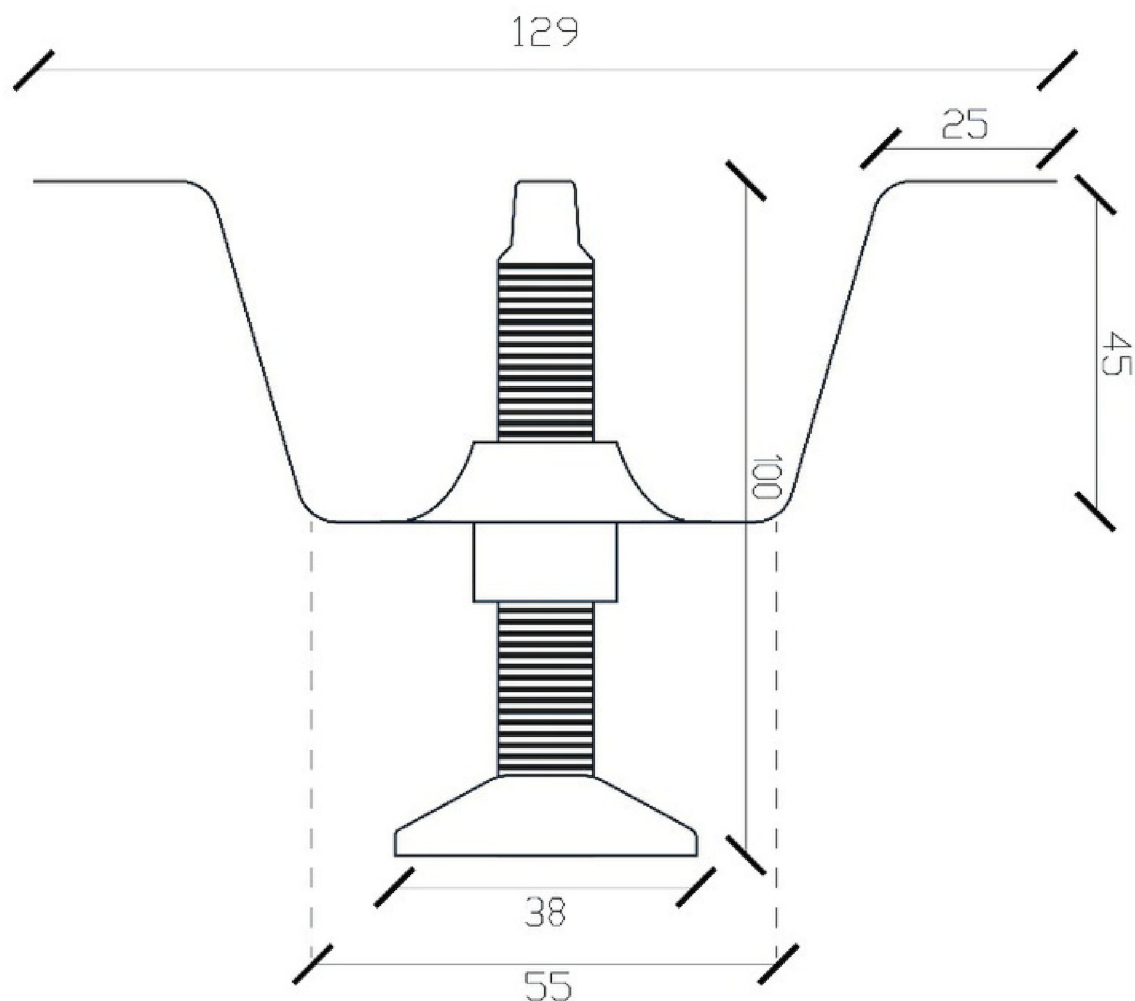

EVERY NON SEATED OMNITUB COMES WITH A FEET KIT TO USE IN YOUR INSTALLATION IF YOU WISH. IT'S OPTIONAL. YOU DON'T HAVE TO USE THEM.

YOU DO NOT NEED TO ADD THESE TO AN ORDER, THEY'RE SHIPPED WITH YOUR ORDER.

DESIGN CONSIDERATIONS

Installed bath height

How high will my bath be from the ground

Generally in older properties, there is adequate access under the floor boards to run the waste trap, waste pipe and any other connections meaning your bath tub can be installed anywhere in the region of 630 mm total height providing the joists run in the required direction to allow the pipes to run through.

In newer properties (commonly from 1960 onwards) there is not enough space underneath the floor boards meaning the waste trap, waste pipe and any other connections are installed above the floor level. This will entail that your installed height will be dependent on how much room those components take.

For example, the plumbing components may require 100 mm, therefore this would mean that your total installed height of your bath tub would be anywhere from 730 mm upwards.

It is important to note that we can not tell you your plumbing components height because this will be dependent on the installers choice of product and property restrictions.

In summary, if your plumbing components can fit underneath the floor level, then the total installed height of the bath tub can be from 630 mm. If your plumbing components can not be installed underneath the floor level, this will be dependent on the total height required for the components plus 630 mm (for example, this could be 100 mm required with the additional 630 mm on top).

EXAMPLE OF BATH TUB WITH UNDER FLOOR SPACE AVAILABLE

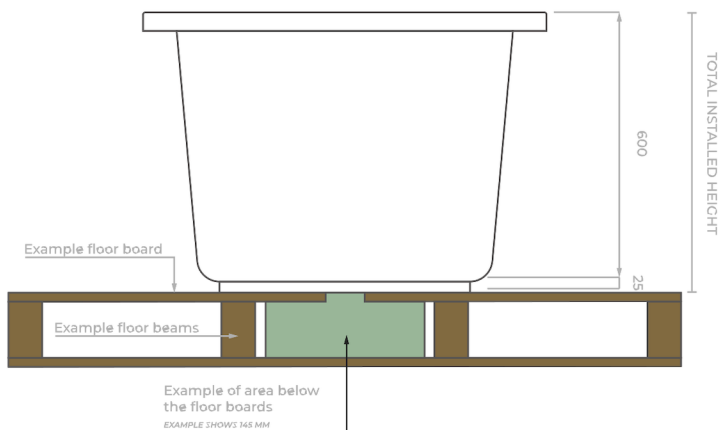

EXAMPLE OF BATH TUB WITH NO AVAILABLE UNDER FLOOR SPACE

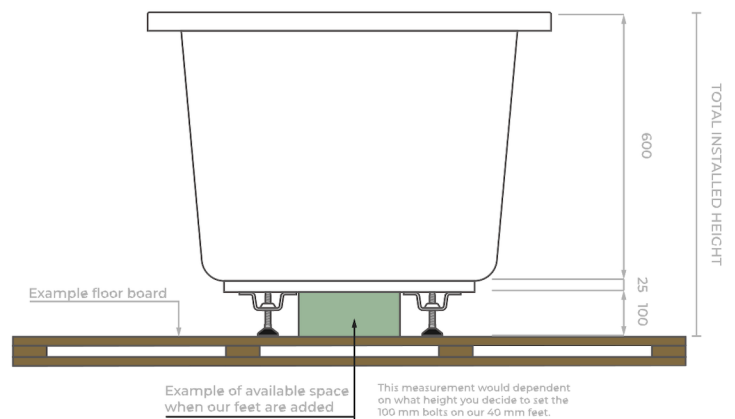

The bath tub shown above is an example but the principal follows suit across all of our standard sizes.

DESIGN CONSIDERATIONS

Cutting the flanges

What you can and can't trim on the flanges

All of our Omnitubs come with 4 flanges around the entire of the bathtub; 1 of which is 100 mm and the other 3 being 75 mm. The structural integrity of the bath tub remains providing that 25 mm has been left on the flange where it is closer to the inside taper.

It is recommended that a qualified bathroom installer/fitter should cut the flanges using a diamond-cut saw blade.



We advise that where the installer may trim/cut the flange, that specific side(s) should be placed against a wall.

When cutting the flanges, please bear in mind that this can potentially limit the space on where you can add tap accessories and overflow accessories.

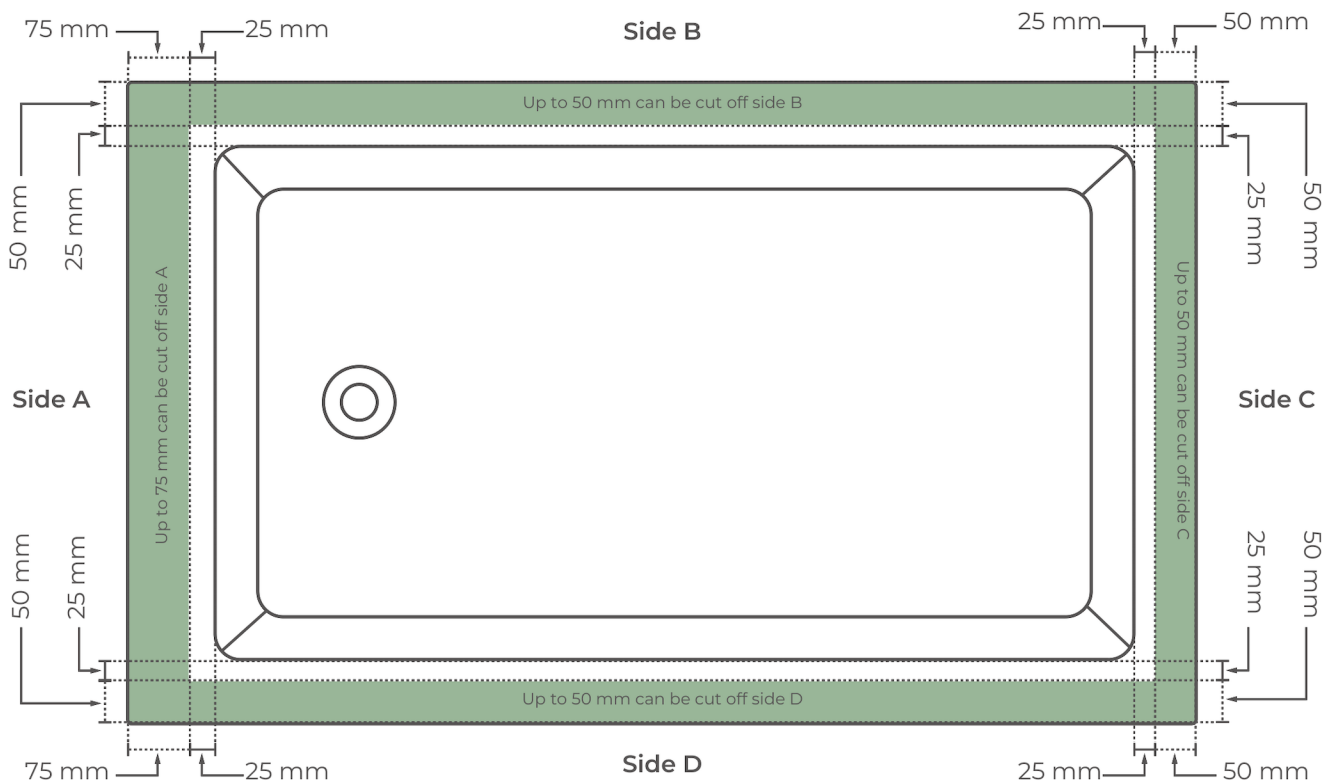
IMPORTANT NOTICE* Ensure that you have carefully thought where the installer will trim because any Omnitub which has had the flanges cut/trimmed will be non-returnable and non-refundable. Omnitub carry out a chargeable cut and trim service which when the flanges have been cut/trimmed, this classes the your Omnitub as a bespoke product which is non-returnable and non-refundable.



The Omnitub shown above is an Omnitub Solo Plus but the principal follows suit across all of our standard sizes.

-  The area(s) shown with this colour code can be cut off using a diamond-cut saw blade
-  The area(s) shown with this colour must be left uncut

DESIGN CONSIDERATIONS

Drilling overflows

How to cut overflow holes into an Omnitub

Fibreglass is an easy material to drill through, therefore drilling an overflow hole into your Omnitub is straightforward for both professional installers/bathroom fitters and the individual home owner. It is important that the person who is drilling the hole into the Omnitub is wearing the correct safety equipment (such as protective goggles) because fibreglass is a bit more sensitive than other materials.

INSTRUCTIONS ON HOW TO DRILL AN OVERFLOW HOLE

1. Make sure to pin point and measure exactly where you want to drill your overflow
2. Look at your chosen overflow mechanisms technical datasheet to understand what size hole needs to be drilled
3. Mark the location of the drill point using a marker pen
4. Once you are confident of the overflows proposed location, set your diamond-cut hole saw to the correct measurement (the standard size overflow hole is 52 mm in diameter, however you must ensure that your hole size will match exactly to your chosen overflow mechanisms technical datasheet)
5. Place the diamond-cut hole saw onto the proposed location and start drilling then pushing gently into the fibreglass material until you have drilled through completely

Drilling holes into our fibreglass bath tubs should be carried out by a professional installer/bathroom fitter. If you do not have much DIY experience, then we would recommend that you contact a qualified plumber, professional bathroom installer/fitter to carry out the work. This will also ensure that the job has been carried out correctly because they will have all of the tools necessary to complete the job.

This principal follows suit across all of our fibreglass bath tubs and can be carried out by any professional bathroom installer/fitter. IMPORTANT NOTICE*

Ensure that you have carefully thought where the hole(s) will be drilled because any Omnitub which has been drilled will be non-returnable and non-refundable. Omnitub carry out a chargeable cut and trim service which when any hole(s) have been drilled, this classes the your Omnitub as a bespoke product which is non-returnable and non-refundable.

DESIGN CONSIDERATIONS

Drilling tap holes

How to cut tap holes into an Omnitub

Fibreglass is an easy material to drill through, therefore drilling tap holes into your Omnitub is straightforward for both professional installers/bathroom fitters and the individual home owner. It is important that the person who is drilling the hole into the Omnitub is wearing the correct safety equipment (such as protective goggles) because fibreglass is a bit more sensitive than other materials.

INSTRUCTIONS ON HOW TO DRILL TAP HOLES

1. Make sure to pin point and measure exactly where you want to drill your tap holes
2. Look at your chosen tap accessories technical datasheet to understand what size hole needs to be drilled
3. Mark the location(s) of the drill point using a marker pen
4. Once you are confident of the proposed tap hole location(s), set your diamond-cut hole saw to the correct measurement
5. Place the diamond-cut hole saw onto the proposed location and start drilling then pushing gently into the fibreglass material until you have drilled through completely
6. Carry out step 5 for each tap hole which needs to be drilled.

Drilling holes into our fibreglass bath tubs should be carried out by a professional installer/bathroom fitter.

If you do not have much DIY experience, then we would recommend that you contact a qualified plumber, professional bathroom installer/fitter to carry out the work. This will also ensure that the job has been carried out correctly because they will have all of the tools necessary to complete the job.

For users who have cut the flanges of their Omnitub, it is important to notice whether your chosen tap accessories will fit onto the proposed flange due to trimmed area.

For all other users who have not cut their flanges, then in most scenarios your proposed tap accessories will fit onto our Omnitub - but please take care and read through your tap accessories technical datasheet to ensure that it will fit onto your preferred flange.

This principal follows suit across all of our fibreglass bath tubs and can be carried out by any professional bathroom installer/fitter. IMPORTANT NOTICE*

Ensure that you have carefully thought where the hole(s) will be drilled because any Omnitub which has been drilled will be non-returnable and non-refundable. Omnitub carry out a chargeable cut and trim service which when any hole(s) have been drilled, this classes the your Omnitub as a bespoke product which is non-returnable and non-refundable.

DESIGN CONSIDERATIONS

Door ways

Considerations when moving through door ways

DOOR WAY ACCESS

We have designed our bath tubs so that they are easy to get through most door ways.

The standard width of a door way in the United Kingdom is 720 to 750 mm. It is important to reference all door way points where the bath tub will need to go through in order to ensure that it easily is transported through without causing any damage to the product and your location.

Where most of our bath tubs are bigger than 720 to 750 mm in width, you must turn the bath tub on its side which means the bath tubs width will become 625 mm giving you plenty of playing room to transport your tub through the door way(s). By standard, we would recommend that your door way must be a minimum of 630 mm. If your door way is less than 630 mm, you will need to do the following:

- Extend your door ways width to allow enough room to transport your bath tub through (this can incur costs at your own expense)
- Find another way to transport your bath tub through to its designated location where the access widths are more than 630 mm

If you are unable to achieve access widths of more than 630 mm, then the bath tub will not go through.

All of our bath tubs can fit through any door way providing it is a minimum of 630 mm in width by turning the bath tub on its side making the bath tubs width 625 mm.

EXAMPLE INTERNAL DOOR

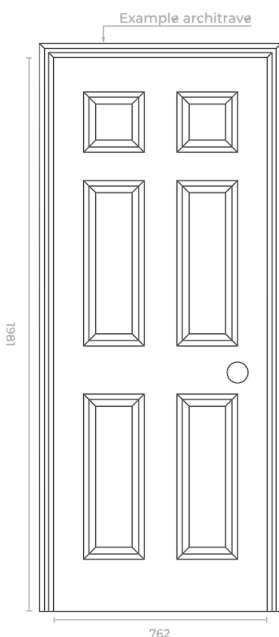

Your door way and access will be different from our example diagram shown above.

EXAMPLE DOOR WITH BATH TUB ON ITS SIDE

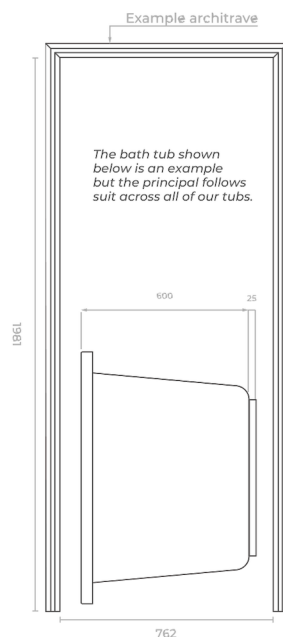

HOW TO GET YOUR BATH TUB THROUGH A DOOR WAY

1. Due to the fibreglass texture on the exterior of the bath tub, it is essential that you wear protective gloves to ensure that you do not get any fibre splinters or cuts onto your hands.
2. Measure the internal door frame and take note of the measurement. If the door way is a minimum of 630 mm, then all of our standard bath tubs will fit through. If it is less than 630 mm, the bath tubs will not fit through.
3. Place a protective material (such as bubble wrap) over the polished side and flanges) to ensure that you do not scratch or damage the bath tub when transporting.
4. Turn the bath tub on its side which will make the width of the bath tub 625 mm.

All of our bath tubs should be transported and lifted using two people.

DESIGN CONSIDERATIONS

Omnitub® Panels

Our Omnitub® Panels create the finished look for your new Omnitub® bath tub by hiding away the frame and fittings beneath. Using our Panels coherently with our Omnitub® bath tubs, it seamlessly blends in with the rest of your decor, resulting in a stylish and sophisticated look.

All of our Omnitub® Panels are manufactured using the same process as our bath tubs meaning that all of our manufactured panels are extremely durable.

The Omnitub® Panels currently come with panel itself, as well as a metal frame with fixings. When you receive one of our Omnitub® Panels, they will be shipped 100 mm longer and 100 mm higher than the standard highest recommended installed height.

If you already know the height which the panel will be required, you are welcome to give us the dimensions of your required panel; however this would make your Panel classed as a bespoke item therefore would not be eligible for a return. If you are planning on tiling over the panel or cladding over it, you should not purchase one of our panels because they have been designed and manufactured to be a complete finish look to match the style of your Omnitub® bath tub.

INSTRUCTIONS ON INSTALLING THE OMNITUB® PANEL

1. Build a wooden frame from the floor to the underside of the tub (underneath the flanges) and the walls.
2. Measure the height and length required to ensure you get an accurate and flush fit.
3. Trim the Omnitub® Panel accordingly using a diamond cut saw blade.
4. Connect the Omnitub® Panel onto the built wooden surround you have built by aligning the magnets on the panel to the metal frame.

We would recommend that your installer realigns the Omnitub® Panel to the bath tub prior to sealing the item with silicone (or equivalent substance) to the bath tub and walls.

In the event where you will need to remove the panel to gain access, simply blade the silicone (or equivalent substance) and pull the panel off of the metal frame.

Right-handed L-shaped Front Bath Panel

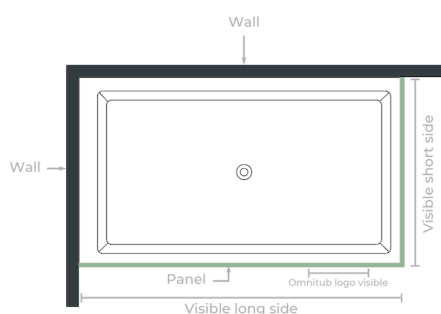

This panel is manufactured as one whole piece and is to be used on an Omnitub® bath tub where the visible long side of the bath tub connects to the visible short side on the right hand-side.

Left-handed L-shaped Front Bath Panel

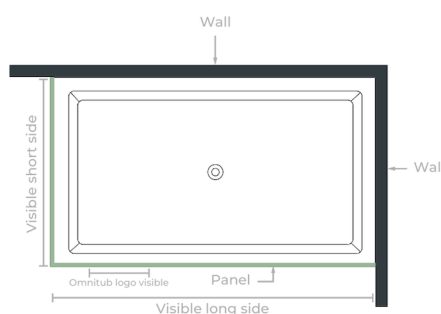

This panel is manufactured as one whole piece and is to be used on an Omnitub® bath tub where the visible long side of the bath tub connects to the visible short side on the left hand-side.

Long or Short sided Front Bath Panel

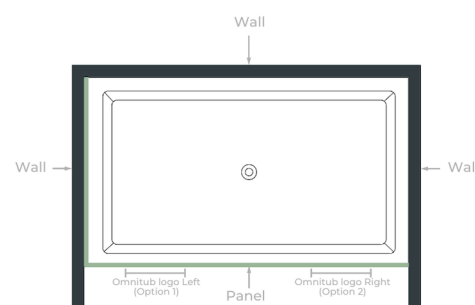

If you have a wall surrounding three sides of your Omnitub® bath tub, then depending on what side is shown will be the type of panel you will require.

IMPORTANT NOTICE* Do not purchase a Long sided front bath panel and a short sided front bath panel in order to create the L-shaped front effect. Ensure that you have purchased the correct panel type prior to proceeding with the order.

MAINTENANCE

Cleaning guide

Instructions on how to clean your Omnitub

HOW OFTEN SHOULD YOU CLEAN YOUR OMNITUB?

It is recommended that you clean your Omnitub regularly to eliminate the chance of mold build-up and will keep your bathroom smelling fresh. If you use your Omnitub regularly, we recommend that you give it a routine clean every week and a deep clean once a month.

REQUIRED PRODUCTS

- Latex gloves
- Squeegee
- Non-abrasive bath cleaner
- Soft sponge
- Dry soft towel

TOP TIPS TO KEEP YOUR TUB CLEAN FOR LONGER

- Remove any excess water from the tapered walls of the tub by using a squeegee to sweep it down the waste hole
- Using a non-abrasive bath cleaner, clean the tile grout to eliminate the chance of mould build-up
- Remove the limescale which can build-up on the end of the taps by using a non-abrasive bath cleaner with sponge/microfibre cloth

INSTRUCTIONS ON HOW TO CLEAN YOUR OMNITUB

- Before getting started, clear all toiletries from the area and slip on latex gloves to protect your skin
- Using a non-abrasive bath cleaner, spray the flanges of the Omnitub and inside of the bath tub
- Using a soft sponge, scrub the tub working from the top down so that the debris falls into the tub as you clean
- Wipe away dirt and spills with a microfibre cloth
- To remove stubborn stains like soap rings, use lemon juice and a mild cream cleanser and apply the mixture onto a soft sponge

Once you have thoroughly cleaned the Omnitub, it is important that you rinse the area with water really well, then wipe completely dry using a dry soft towel to avoid streaks.

To help keep your bath fresh in-between deep cleans, rinse well, wipe away excess moisture and let the area thoroughly dry between each use.

By keeping your bath clean and sanitized will not only leave it sparkling, but it will also keep everyone using the bath tub happy and healthy.

IMPORTANT KEY NOTES

- To remove tough grout stains, scrub a mixture of baking soda and vinegar and use a small narrow soft brush to eliminate the debris from the Omnitub. However, please note that if you decide to carry out this method, your bath tub will lose its polished finish and become a matt finish. To fix this, you will need to speak to someone who can hand-hold polish your Omnitub.
- You must not use abrasive cleaning materials such as bleach to clean your Omnitub. We will not cover any bath tub where it has had an abrasive material used to carry out any form of cleaning or maintenance.

MANUFACTURERS GUARANTEE 30 YEARS



As a reputable manufacturer, we are personally prepared to support our customers with a **meaningful guarantee lasting up to 30 years.**

For a full explanation of our manufacturers guarantee, please visit www.omnitub.co.uk/manufacturers-guarantee

It is important to note that our 30 year manufacturer guarantee covers manufacturing faults and defects only. It does not cover and will not accept claims for accidental damage or fair wear & tear.

omnitub.co.uk

APPROVED BY OMNITUB'S
QUALITY ASSURANCE DEPARTMENT

(+44) 1934 751 200

INFO@OMNITUB.CO.UK

THIS CERTIFICATE WAS APPROVED BY

All board of directors at Omnitub Ltd

DIRECTOR

Company Number: 05008946

Omnitub Ltd
4 King Square, Bridgwater, Somerset, TA6 3YF

omnitub.co.uk

WARRANTY

Omnitub Ltd guarantees that all of our Omnitub® bath tubs are fit for purpose and that its design and manufacturing process conforms to all relevant legislation ensuring that the products sent to the recipient is free of any defects in relation to both materials and workmanship.

Whilst all of our Omnitub® bath tubs are manufactured from reinforced fibreglass, all manufactured products carry a 30-year manufacturers guarantee against structural failure, loss of rigidity, leakage, and surface breakdown.

It is important to note that prior to any product being dispatched from any affiliated address in relation to Omnitub Ltd, all products undergo our companies standard Quality Assurance procedure to ensure that the item(s) are fit for purpose and free of any defects.

In the unlikely event of any faults occurring on your Omnitub® bath tub or other manufactured product sold by Omnitub Ltd, our organisation will carry out the following process:

- Obtain and compile all digital imagery in relation to the order in question
- Analyse all digital imagery in-house by our Quality Assurance team

If the Omnitub® manufactured products are found to have been damaged prior to the order being dispatched, then our organisation will carry out the following:

- Exchange the faulty product for a new product of the same specification
- Repair and refurbish faults which are deemed as minor at Omnitub Ltd's own expense

Omnitub Ltd will not accept any liability for any consequential loss caused by the inconvenience.

OUR WARRANTY DOES NOT COVER THE FOLLOWING

- Omnitub Ltd will not cover any damage caused by misuse, poor maintenance or lack of care.
- Omnitub Ltd will not cover any damage caused by exposure to abrasive materials and equipment, harmful cleaning materials and chemicals, and exposure to naked flames.
- Omnitub Ltd will not cover any form of normal wear and tear.
- Omnitub Ltd will not cover damage caused by improper installation.
- Omnitub Ltd will not cover any damage caused by failure of waterproof sealing any hole drilled into the Omnitub® bath tub where the drilling has occurred at any of our affiliated locations.
- Omnitub Ltd will not cover any alterations to any Omnitub® bath tub or manufactured product.

PLEASE NOTE* All judgements by an authorised body of Omnitub Ltd are final.